

# 電験革命

## 理論編

作成者：Lese



## ■ 電源側の $\Delta$ -Y変換

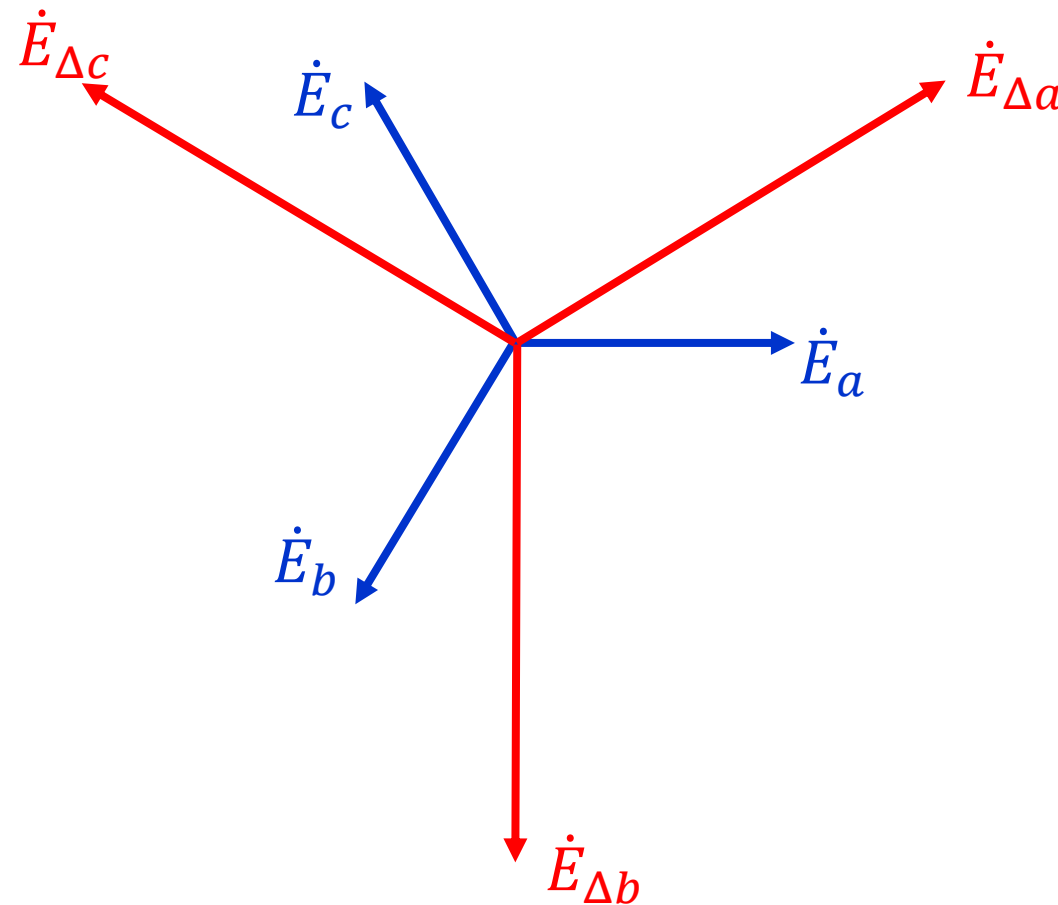
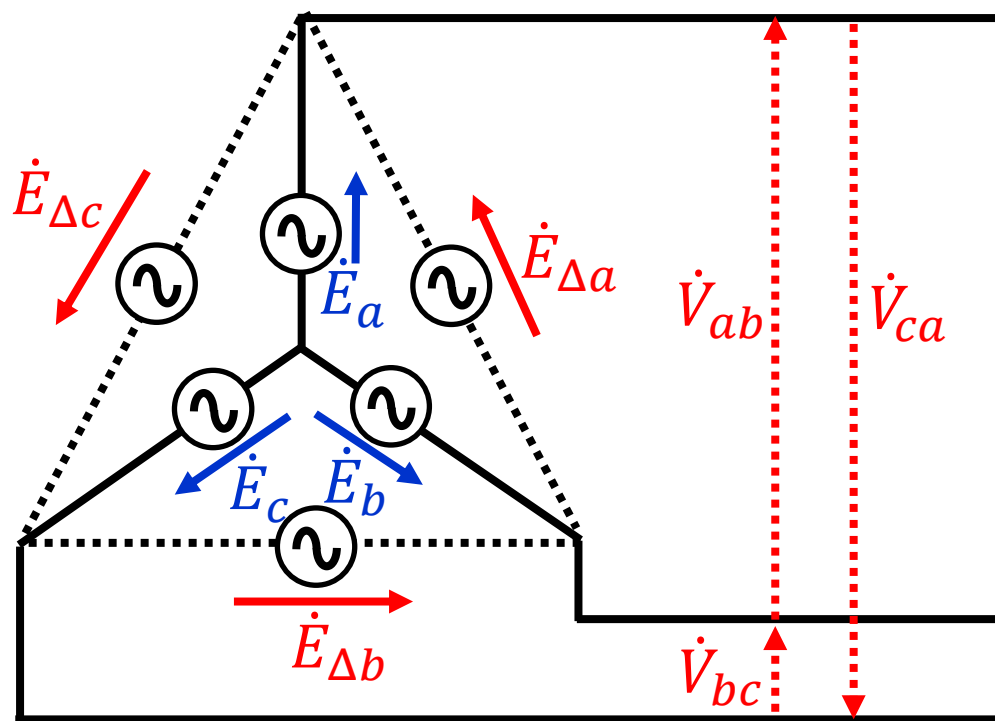

電源側のY  $\rightarrow$   $\Delta$ 変換では、大きさが $\sqrt{3}$ 倍となる。

## ■ 負荷側の $\Delta$ -Y変換

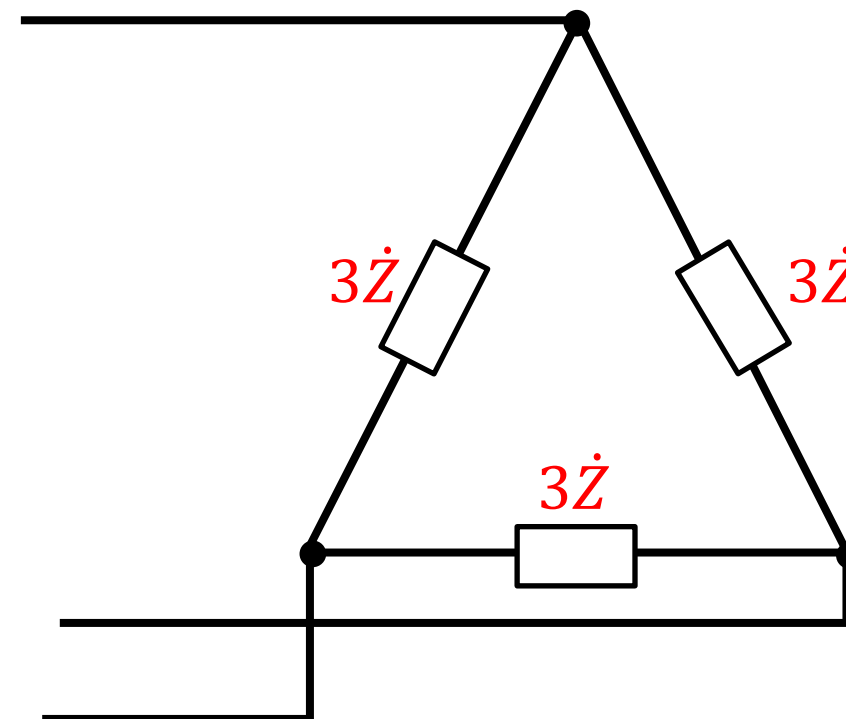
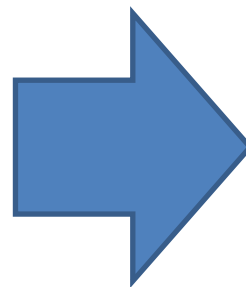
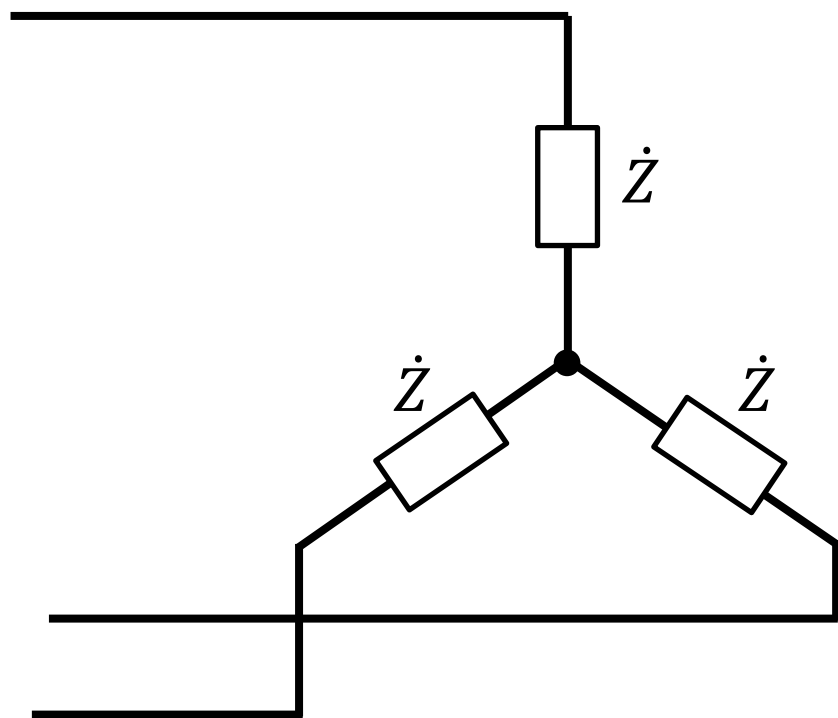

負荷側のY  $\rightarrow$   $\Delta$ 変換は、従来通りインピーダンスが3倍となる。

## ■ 負荷側の $\Delta$ -Y変換(例)

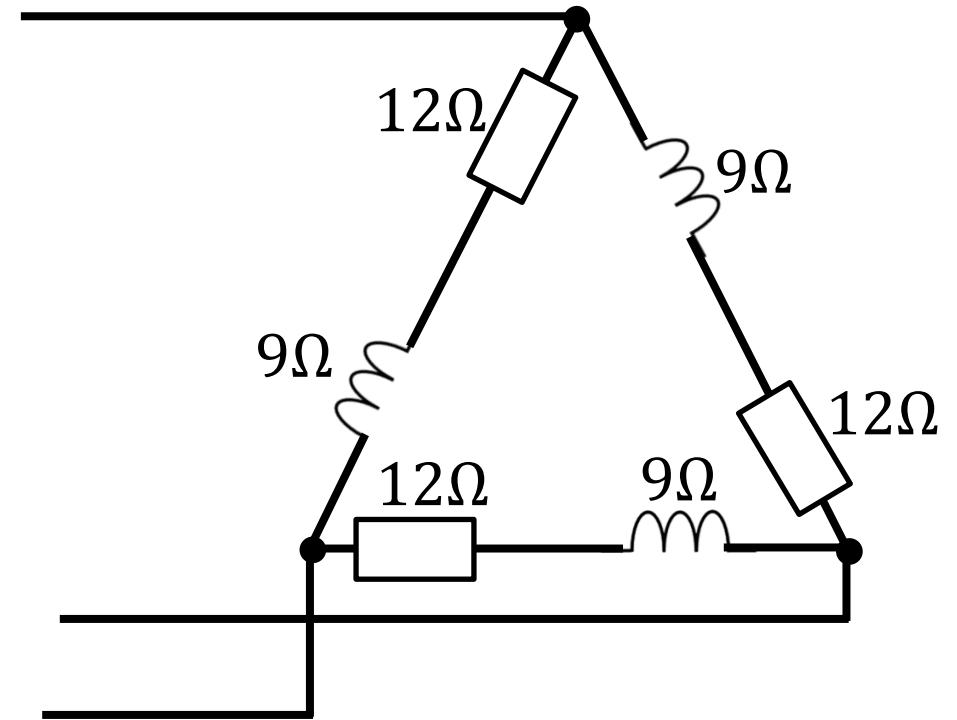
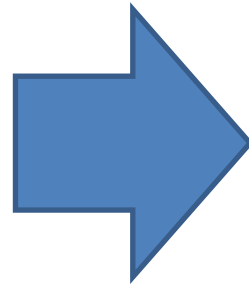
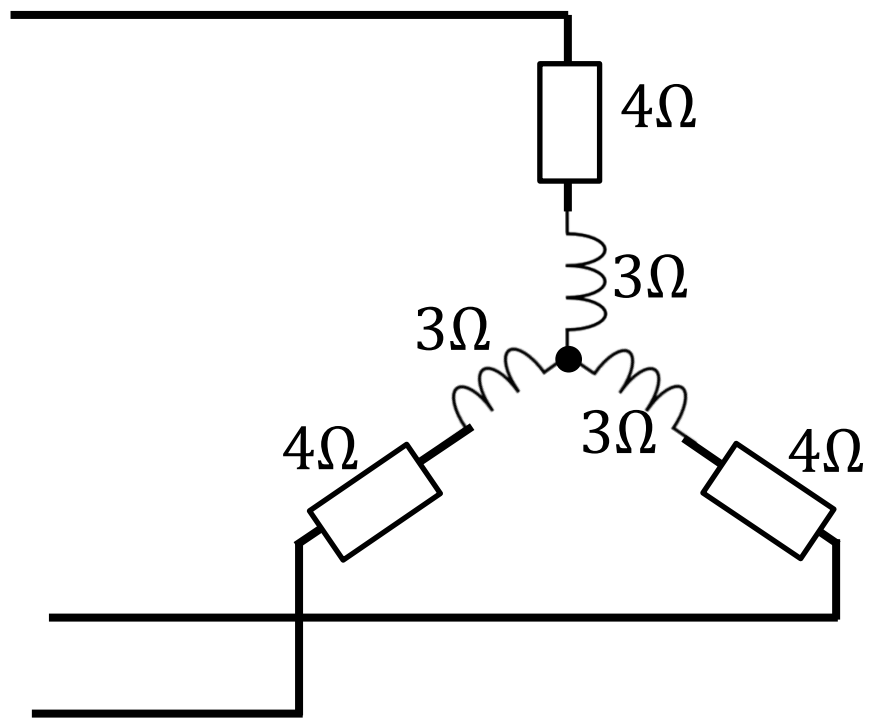

## ■ 負荷側の $\Delta$ -Y変換(コンデンサ)

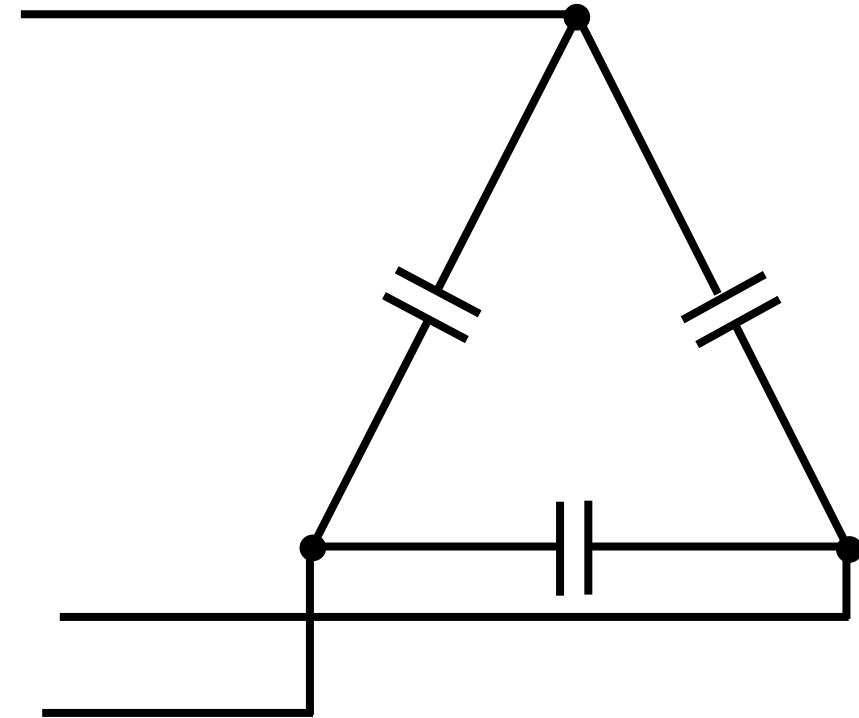
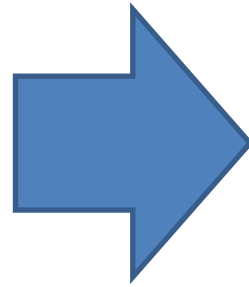
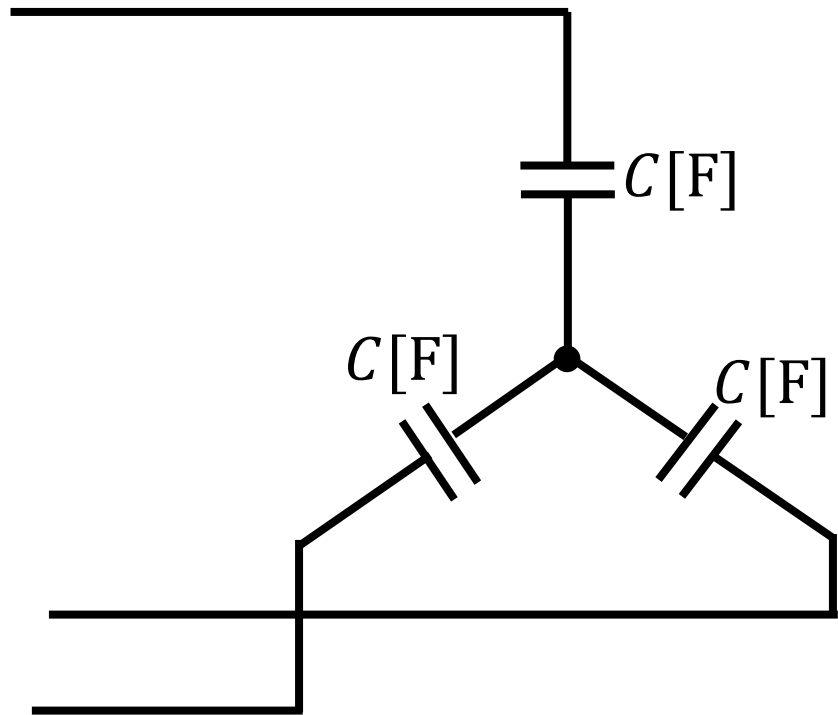

## ■ 負荷側の $\Delta$ -Y変換(コンデンサ)

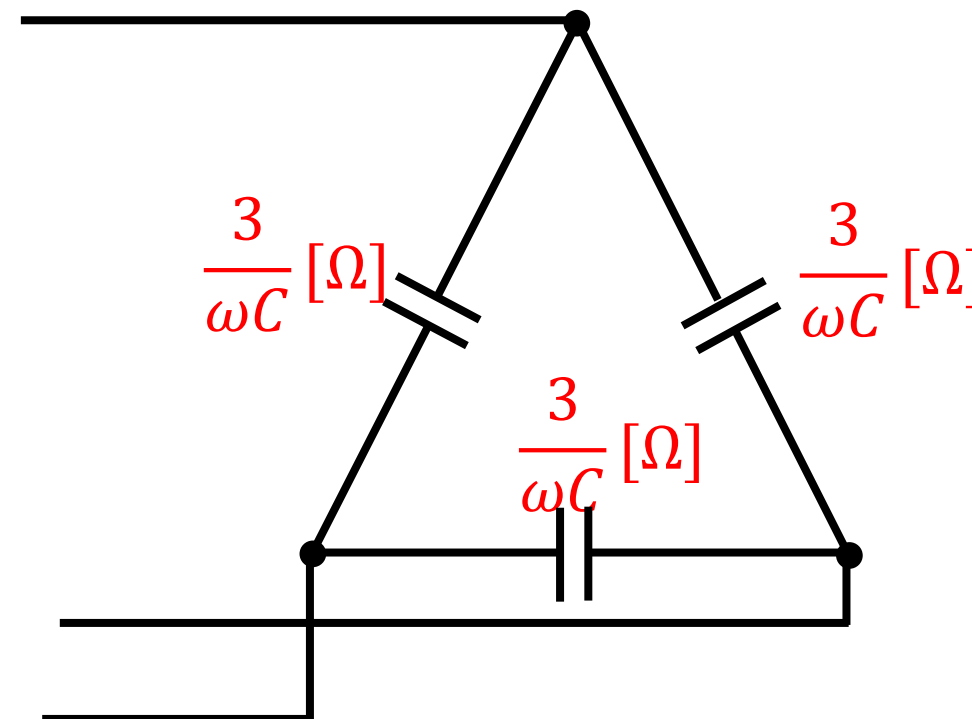
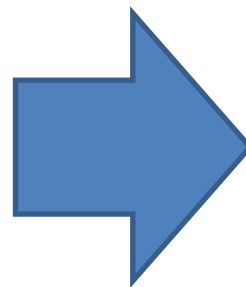
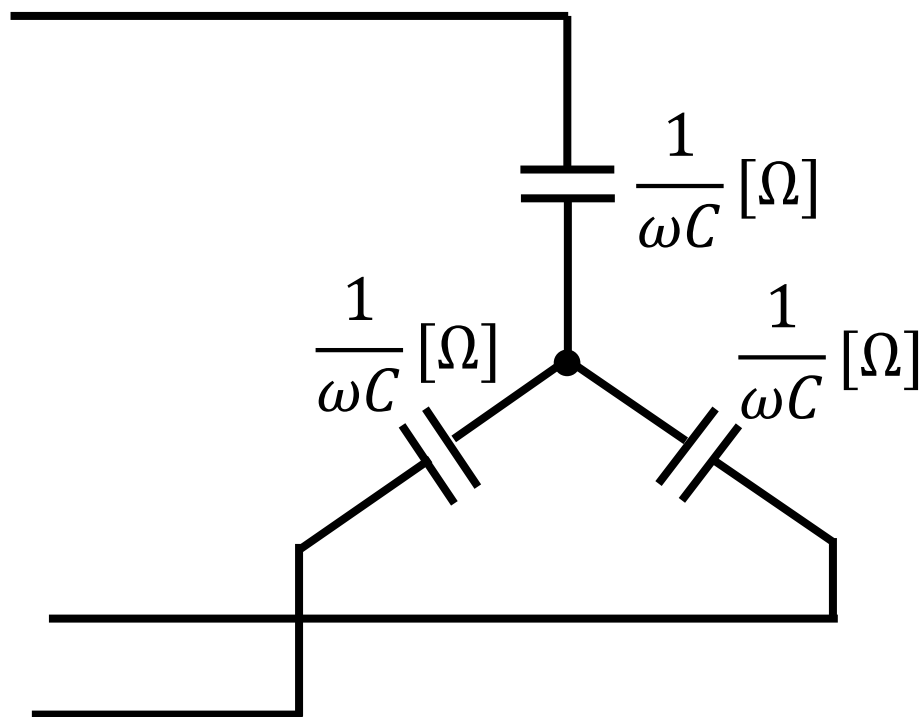

## ■ 負荷側の $\Delta$ -Y変換(コンデンサ)

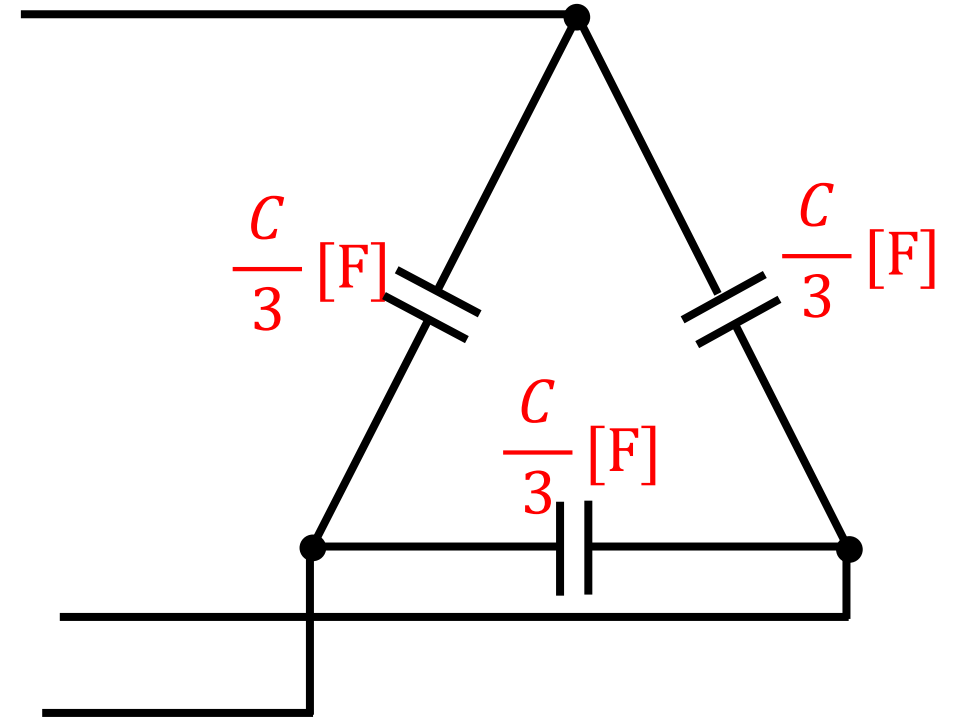
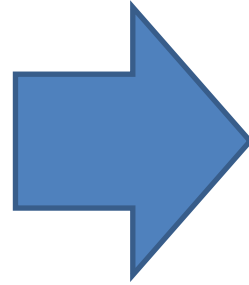
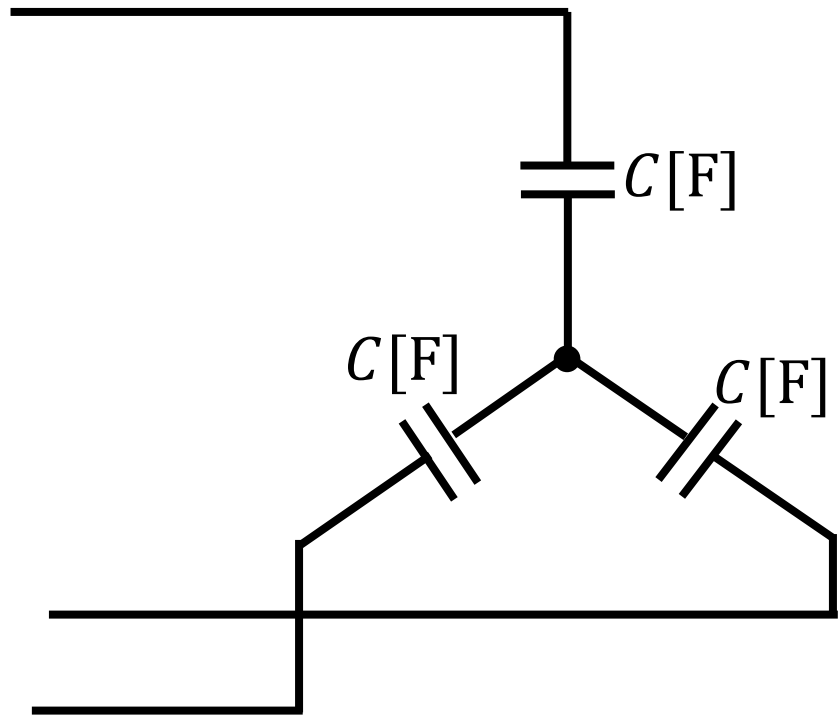

## ■ 負荷側の $\Delta$ -Y変換( $\Delta$ とYが混合ver)

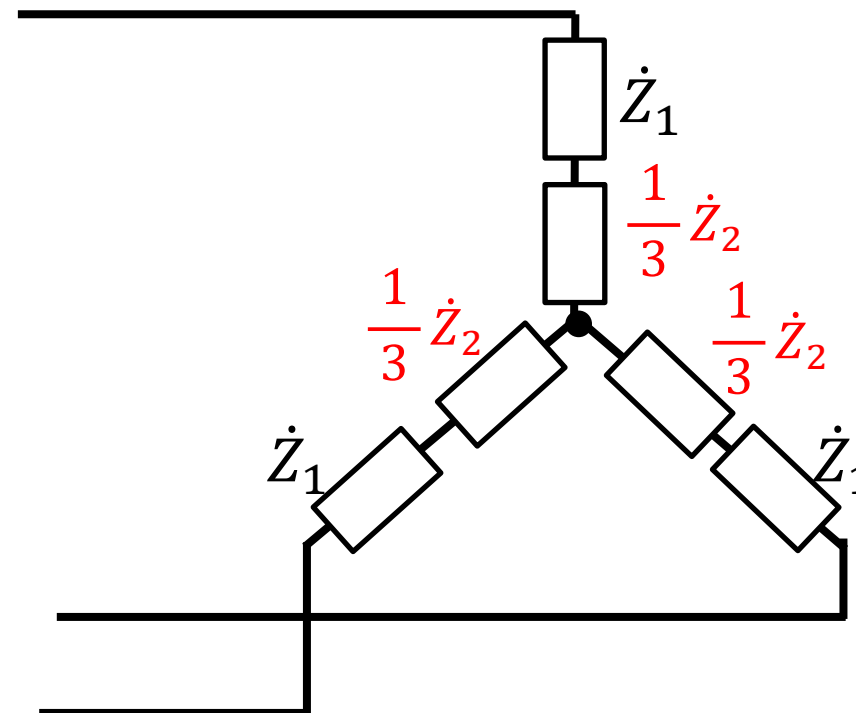
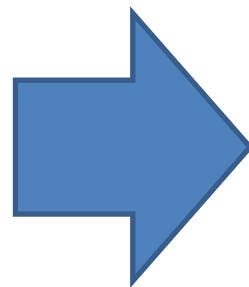
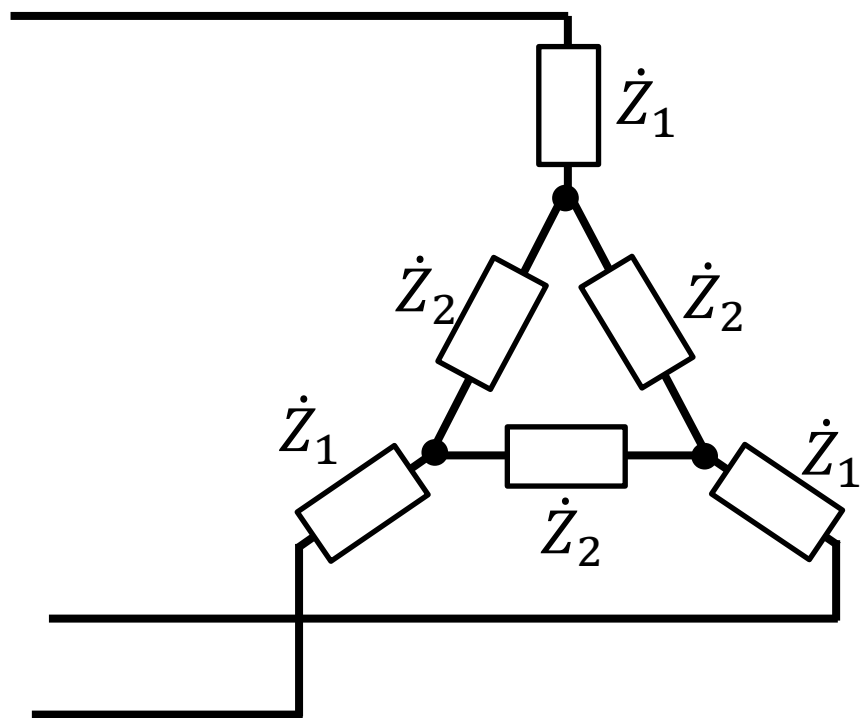



## ■ 負荷側の $\Delta$ -Y変換(並列ver)

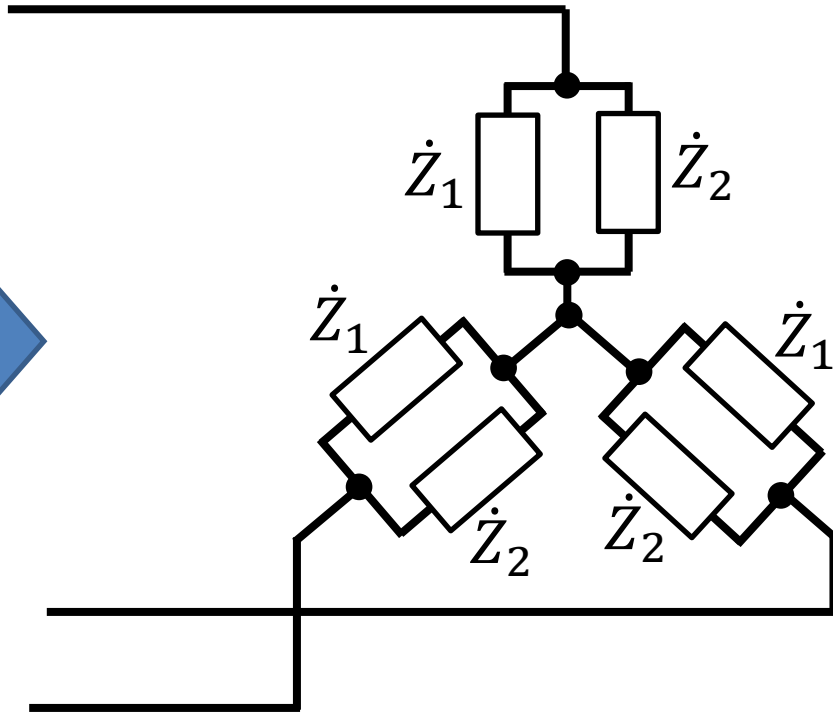
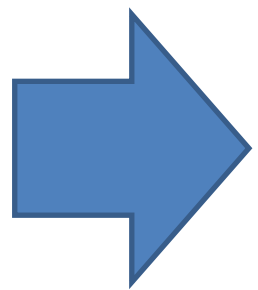
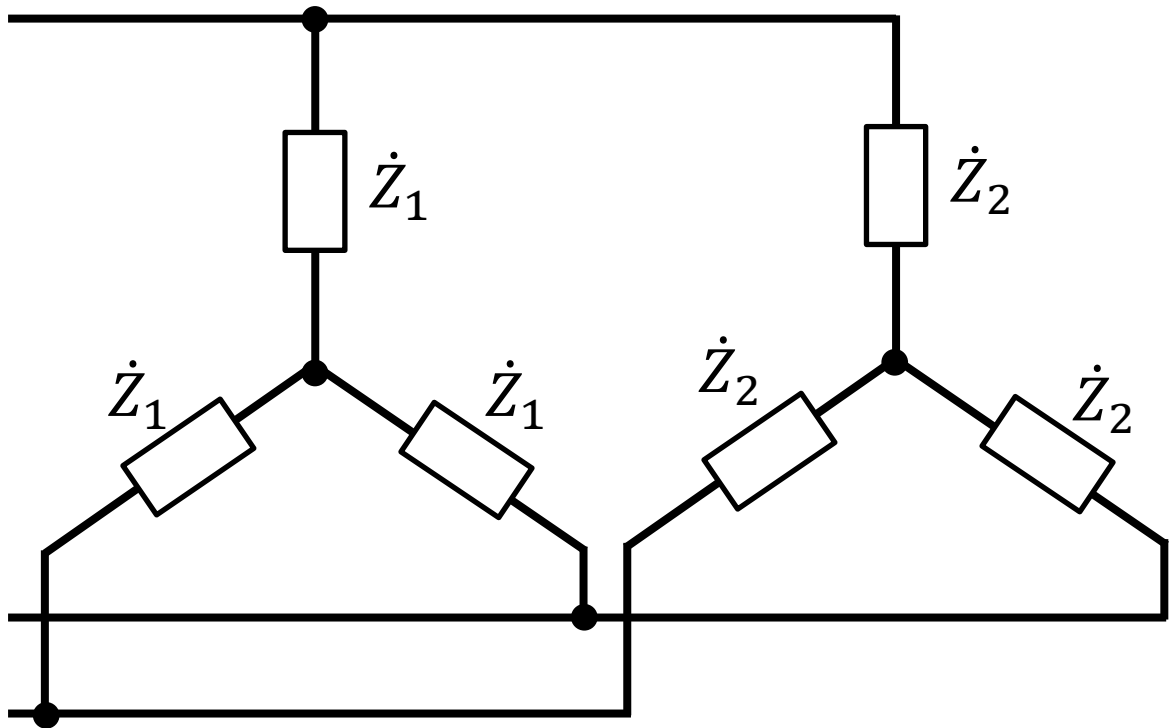

## ■ 負荷側の $\Delta$ -Y変換

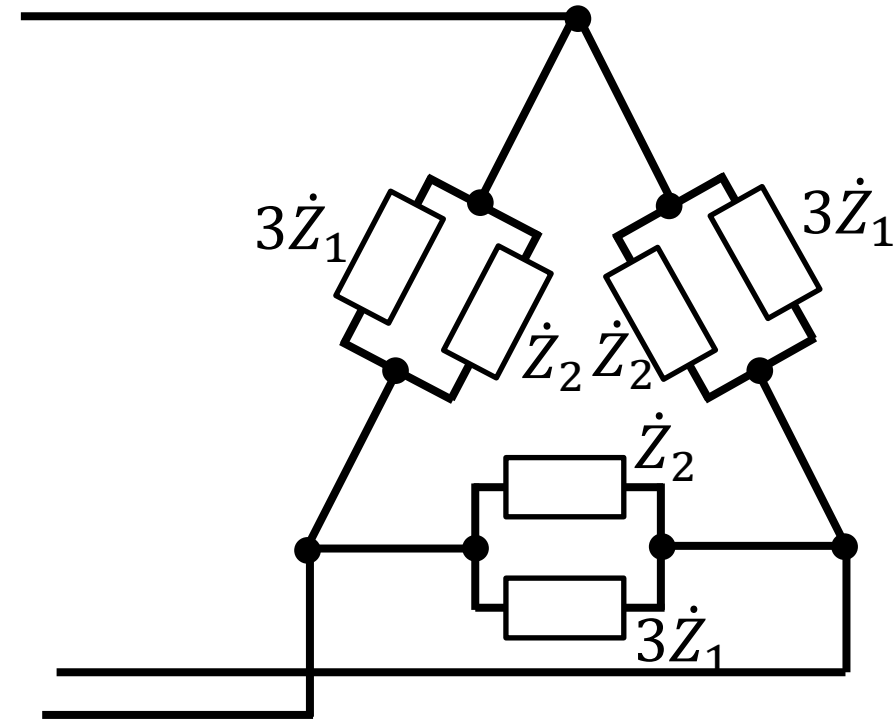
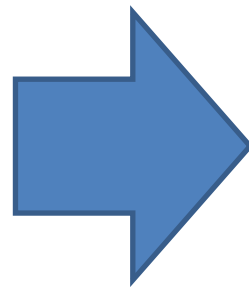
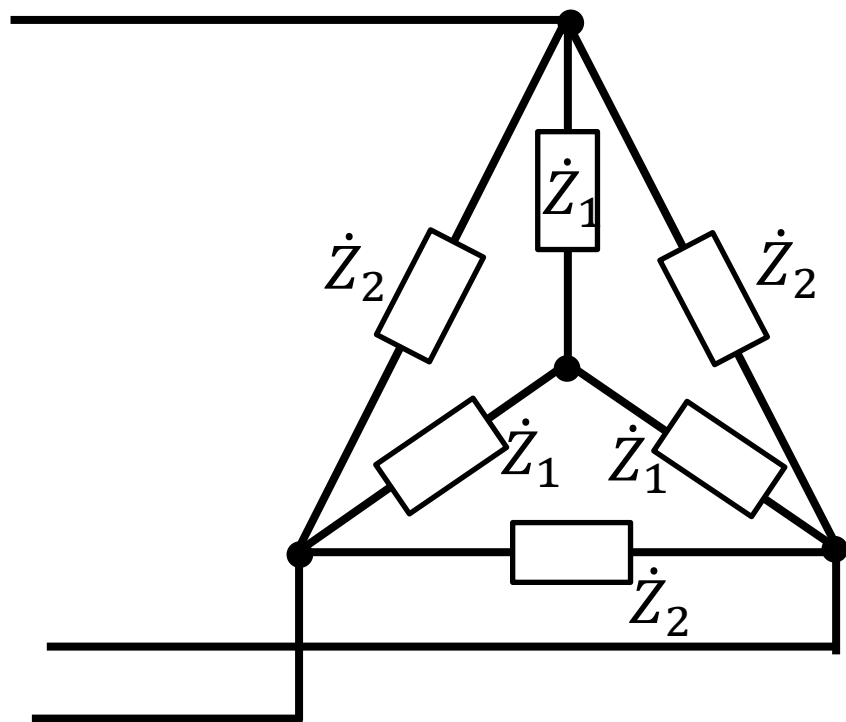

最後までご視聴  
ありがとうございました！

チャンネル登録

！ 基礎から始める

電験3種  
書き込み式  
最強計算ドリル

電験3種用  
書き込み式最強計算ドリル  
Amazonで販売中！！

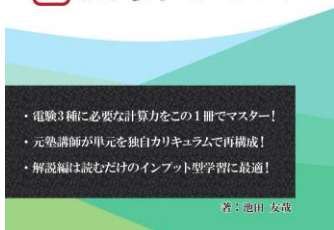

Twitterもやっています！



次回もお楽しみに！

↑チャンネル登録

@riron\_saisoku

@kosen\_go

